

ぶるぶるベル試作機Ⅱ

ぶるぶる工房

HP <http://hccweb1.bai.ne.jp/hce26601/>

メール hce26601@hcc5.bai.ne.jp

改訂

2013/03/10 ①版 ぶるぶるベル試作機Ⅱ接続図

概要

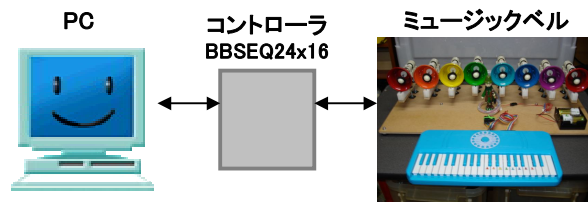

コンピュータ・スマートフォンよりミュージックベル(ハンドベル)を鳴らします。





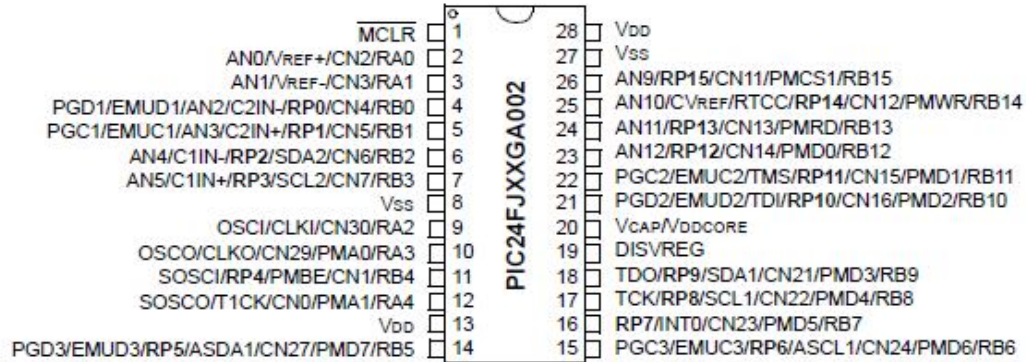













PIC

PIC24FJ64GA002



接続図1 (C16)

PIC信号
入出力(P)信号
アナログ入力(AN)信号
通信 (UART/SPI/I2C)信号
汎用I/O(G)信号

-  モジュール  R1 10KΩ
-  ピンヘッダ  R2 200Ω
-  ジャンパー  C1 10μF
-  Vcc(5V)  C2 0.1μF
-  Vdd(3.3V)
-  Vss(GND)
-  電池(1.5V)
-  T1 2SC3420
-  D1 IN4007
-  TA7291P
-  M1 FM34F
-  M2 DCモータ
-   = 





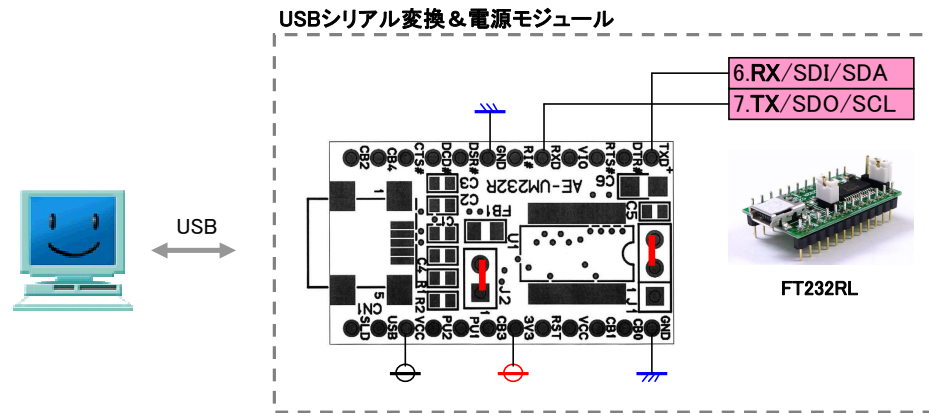











PICピン一覧

1.#MCLR	#MCLR	28.Vdd	Vdd
2.P0	AN0/VREF+/CN2/RA0	27.Vss	Vss
3.P1	AN1/VREF-/CN3/RA1	26.P15	AN9/RP15/CN11/PMCS1/RB15
4.AN	PGD1/EMUD1/AN2/C2IN-/RP0/CN4/RB0	25.P14	AN10/CV../RTCC/RP14/CN12/PM../RB14
5.G0/SCK/G0	PGC1/EMUC1/AN3/C2IN+/RP1/CN5/RB1	24.P13	AN11/RP13/CN13/PMRD/RB13
6.RX/SDI/SDA	AN4/C1IN-/RP2/SDA2/CN6/RB2	23.P12	AN12/RP12/CN14/PMD0/RB12
7.TX/SDO/SCL	AN5/C1IN+/RP3/SCL2/CN7/RB3	22.P11/PGC2	PGC2/EMUC2/RP11/CN15/PMD1/RB11
8.Vss	Vss	21.P10/PGD2	PGD2/EMUD2/RP10/CN16/PMD2/RB10
9.P2	OSCI/CLKI/CN30/RA2	20.VCAP/VDD...	VCAP/VDDCORE
10.P3	OSCO/CLKO/CN29/RA3	19.DISVREG	DISVREG
11.G1	SOSCI/RP4/CN1/RB4	18.P9	RP9/SDA1/CN21/PMD3/RB9
12.P4	SOSCO/T1CK/CN0/RA4	17.P8	RP8/SCL1/CN22/PMD4/RB8
13.Vdd	Vdd	16.P7	RP7/INT0/CN23/PMD5/RB7
14.P5	PGD3/EMUD3/RP5/ASDA1/CN27/PMD7/RB5	15.P6	PGC3/EMUC3/RP6/ASCL1/CN24/PMD6/RB6



接続図1 (L16)

PIC信号
入出力(P)信号
アナログ入力(AN)信号
通信 (UART/SPI/I2C)信号
汎用I/O(G)信号

-  モジュール  R1 10KΩ
-  ピンヘッダ  R2 200Ω
-  ジャンパー  C1 10μF
-  Vcc(5V)  C2 0.1μF
-  Vdd(3.3V)
-  Vss(GND)
-  電池(1.5V)
-  T1 2SC3420
-  D1 IN4007
-  TA7291P
-  M1 FM34F
-  M2 DCモータ

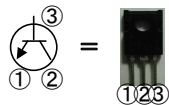

PICピン一覧

1.#MCLR	#MCLR	28.Vdd	Vdd
2.P0	AN0/VREF+/CN2/RA0	27.Vss	Vss
3.P1	AN1/VREF-/CN3/RA1	26.P15	AN9/RP15/CN11/PMCS1/RB15
4.AN	PGD1/EMUD1/AN2/C2IN-/RP0/CN4/RB0	25.P14	AN10/CV../RTCC/RP14/CN12/PM../RB14
5.G0/SCK/G0	PGC1/EMUC1/AN3/C2IN+/RP1/CN5/RB1	24.P13	AN11/RP13/CN13/PMRD/RB13
6.RX/SDI/SDA	AN4/C1IN-/RP2/SDA2/CN6/RB2	23.P12	AN12/RP12/CN14/PMD0/RB12
7.TX/SDO/SCL	AN5/C1IN+/RP3/SCL2/CN7/RB3	22.P11/PGC2	PGC2/EMUC2/RP11/CN15/PMD1/RB11
8.Vss	Vss	21.P10/PGD2	PGD2/EMUD2/RP10/CN16/PMD2/RB10
9.P2	OSCI/CLKI/CN30/RA2	20.VCAP/VDD...	VCAP/VDDCORE
10.P3	OSCO/CLKO/CN29/RA3	19.DISVREG	DISVREG
11.G1	SOSCI/RP4/CN1/RB4	18.P9	RP9/SDA1/CN21/PMD3/RB9
12.P4	SOSCO/T1CK/CN0/RA4	17.P8	RP8/SCL1/CN22/PMD4/RB8
13.Vdd	Vdd	16.P7	RP7/INT0/CN23/PMD5/RB7
14.P5	PGD3/EMUD3/RP5/ASDA1/CN27/PMD7/RB5	15.P6	PGC3/EMUC3/RP6/ASCL1/CN24/PMD6/RB6

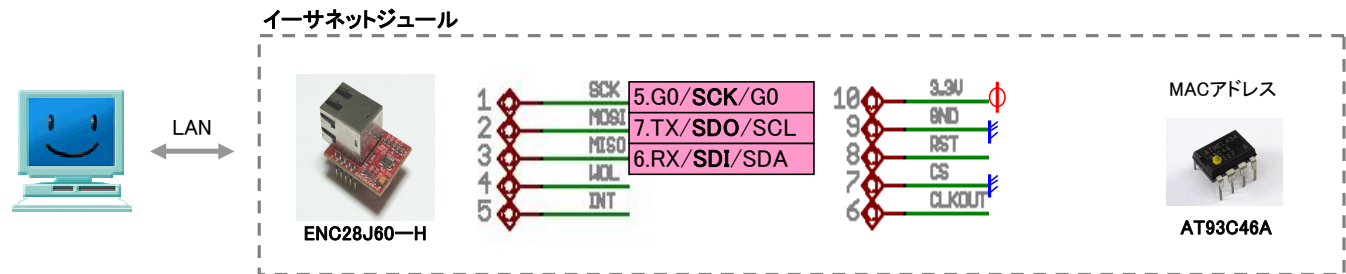

電源モジュール

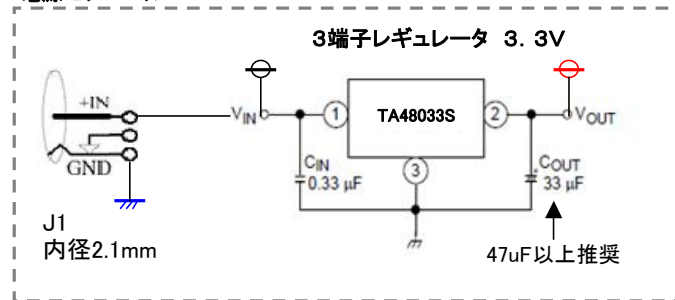

予定(無線LANモジュール)

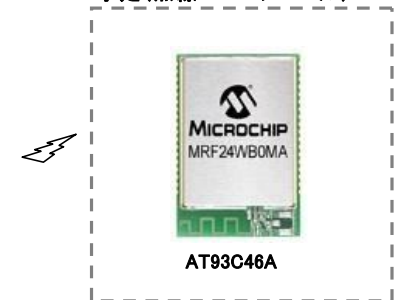

接続図2

PIC信号
入出力(P)信号
アナログ入力(AN)信号
通信(UART/SPI/I2C)信号
汎用I/O(G)信号

	モジュール		R1 10KΩ
	ピンヘッダ		R2 200Ω
	ジャンパー		C1 10μF
	Vcc(5V)		C2 0.1μF
	Vdd(3.3V)		
	Vss(GND)		
	電池(1.5V)		
	T1 2SC3420		
	D1 IN4007		
	TA7291P		
	M1 FM34F		
	M2 DCモータ		

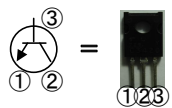





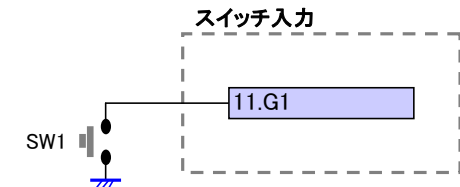
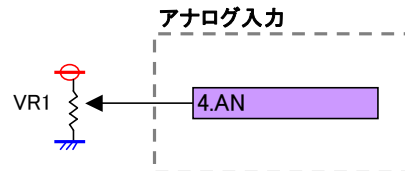
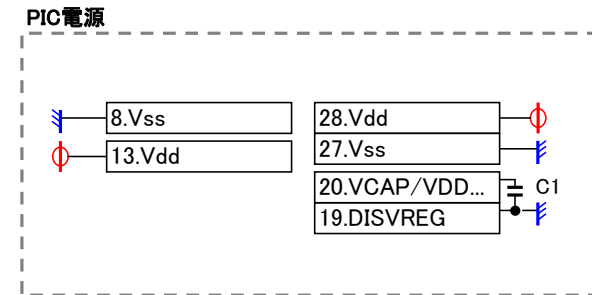
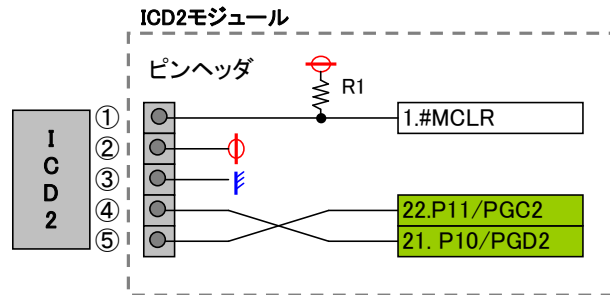







PICピン一覧

1.#MCLR	#MCLR	28.Vdd	Vdd
2.P0	AN0/VREF+/CN2/RA0	27.Vss	Vss
3.P1	AN1/VREF-/CN3/RA1	26.P15	AN9/RP15/CN11/PMCS1/RB15
4.AN	PGD1/EMUD1/AN2/C2IN-/RP0/CN4/RB0	25.P14	AN10/CV../RTCC/RP14/CN12/PM../RB14
5.G0/SCK/G0	PGC1/EMUC1/AN3/C2IN+/RP1/CN5/RB1	24.P13	AN11/RP13/CN13/PMRD/RB13
6.RX/SDI/SDA	AN4/C1IN-/RP2/SDA2/CN6/RB2	23.P12	AN12/RP12/CN14/PMD0/RB12
7.TX/SDO/SCL	AN5/C1IN+/RP3/SCL2/CN7/RB3	22.P11/PGC2	PGC2/EMUC2/RP11/CN15/PMD1/RB11
8.Vss	Vss	21.P10/PGD2	PGD2/EMUD2/RP10/CN16/PMD2/RB10
9.P2	OSCI/CLKI/CN30/RA2	20.VCAP/VDD...	VCAP/VDDCORE
10.P3	OSCO/CLKO/CN29/RA3	19.DISVREG	DISVREG
11.G1	SOSCI/RP4/CN1/RB4	18.P9	RP9/SDA1/CN21/PMD3/RB9
12.P4	SOSCO/T1CK/CN0/RA4	17.P8	RP8/SCL1/CN22/PMD4/RB8
13.Vdd	Vdd	16.P7	RP7/INT0/CN23/PMD5/RB7
14.P5	PGD3/EMUD3/RP5/ASDA1/CN27/PMD7/RB5	15.P6	PGC3/EMUC3/RP6/ASCL1/CN24/PMD6/RB6



接続図3

PIC信号
入出力(P)信号
アナログ入力(AN)信号
通信(UART/SPI/I2C)信号
汎用I/O(G)信号

-  モジュール R1 10K Ω
-  ピンヘッダ R2 200 Ω
-  ジャンパー C1 10 μF
-  Vcc(5V) C2 0.1 μF
-  Vdd(3.3V)
-  Vss(GND)
-  電池(1.5V)
-  T1 2SC3420
-  D1 IN4007
-  TA7291P
-  M1 FM34F
-  M2 DCモータ
-  C1 C2

PICピン一覧

1.#MCLR	#MCLR	28.Vdd	Vdd
2.P0	AN0/VREF+/CN2/RA0	27.Vss	Vss
3.P1	AN1/VREF-/CN3/RA1	26.P15	AN9/RP15/CN11/PMCS1/RB15
4.AN	PGD1/EMUD1/AN2/C2IN-/RP0/CN4/RB0	25.P14	AN10/CV../RTCC/RP14/CN12/PM../RB14
5.G0/SCK/G0	PGC1/EMUC1/AN3/C2IN+/RP1/CN5/RB1	24.P13	AN11/RP13/CN13/PMRD/RB13
6.RX/SDI/SDA	AN4/C1IN-/RP2/SDA2/CN6/RB2	23.P12	AN12/RP12/CN14/PMD0/RB12
7.TX/SDO/SCL	AN5/C1IN+/RP3/SCL2/CN7/RB3	22.P11/PGC2	PGC2/EMUC2/RP11/CN15/PMD1/RB11
8.Vss	Vss	21.P10/PGD2	PGD2/EMUD2/RP10/CN16/PMD2/RB10
9.P2	OSCI/CLKI/CN30/RA2	20.VCAP/VDD...	VCAP/VDDCORE
10.P3	OSCO/CLKO/CN29/RA3	19.DISVREG	DISVREG
11.G1	SOSCI/RP4/CN1/RB4	18.P9	RP9/SDA1/CN21/PMD3/RB9
12.P4	SOSCO/T1CK/CN0/RA4	17.P8	RP8/SCL1/CN22/PMD4/RB8
13.Vdd	Vdd	16.P7	RP7/INT0/CN23/PMD5/RB7
14.P5	PGD3/EMUD3/RP5/ASDA1/CN27/PMD7/RB5	15.P6	PGC3/EMUC3/RP6/ASCL1/CN24/PMD6/RB6

入出力(P)モジュール(例:ぶるぶるベル試作機2)



写真1



写真2

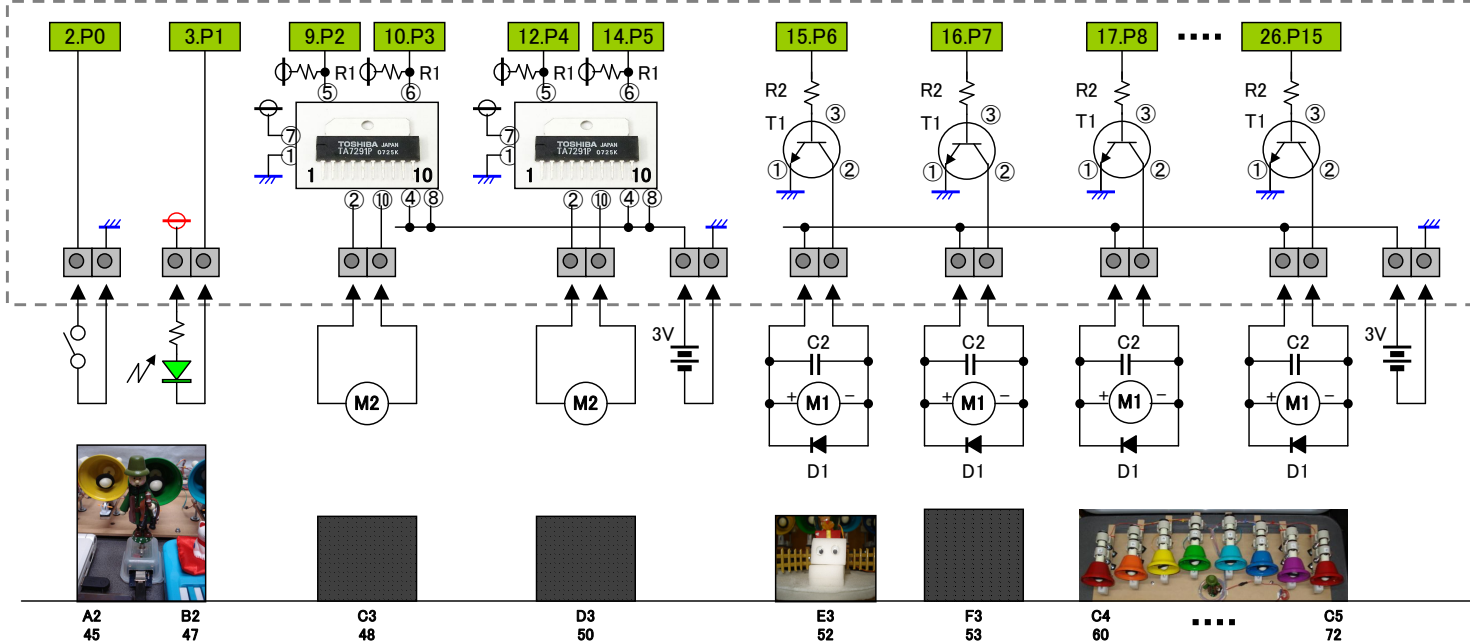
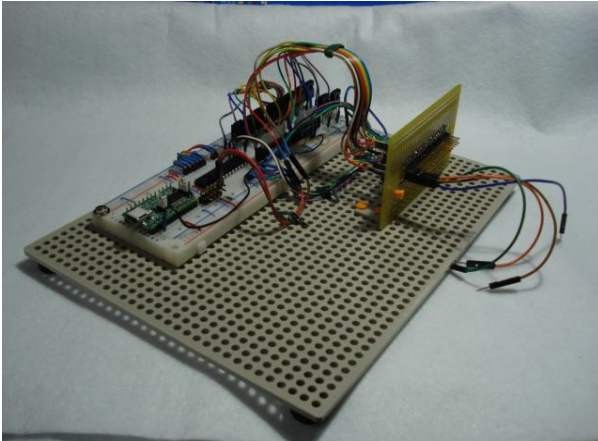
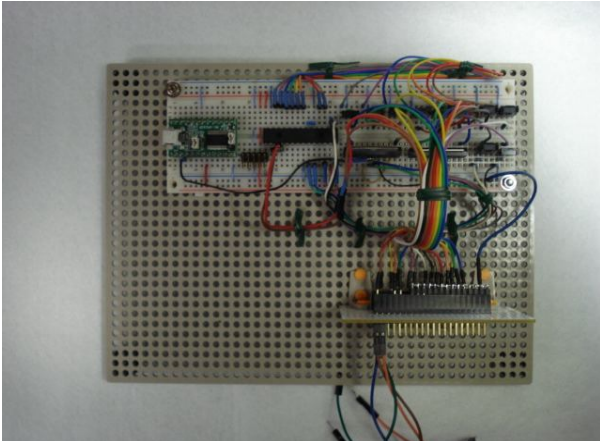
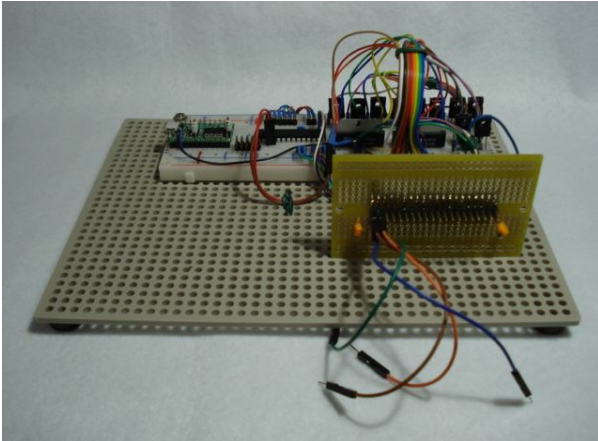
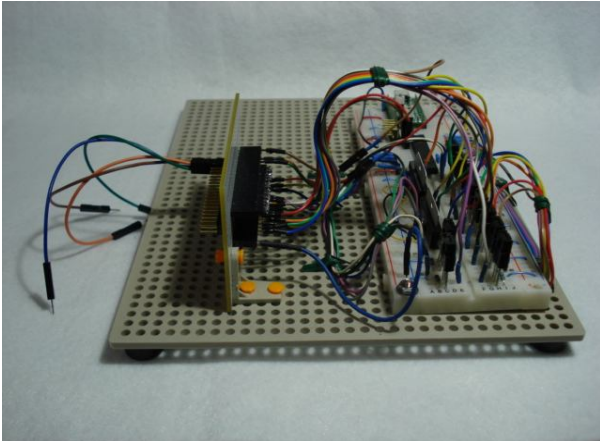
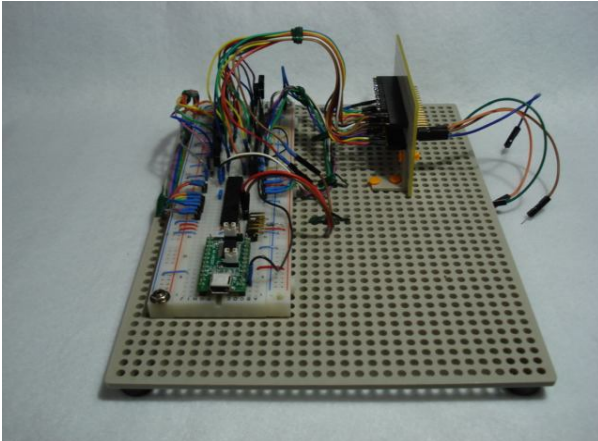
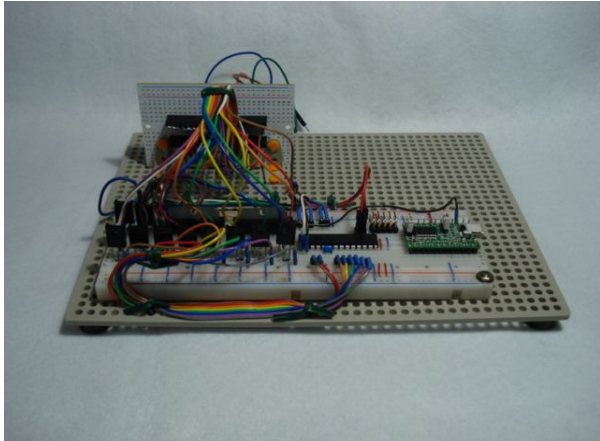
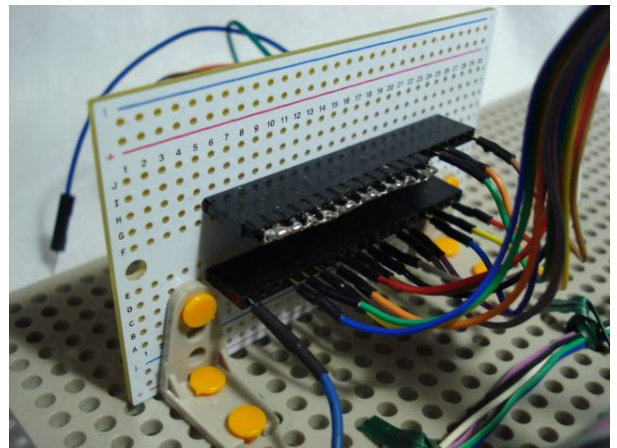
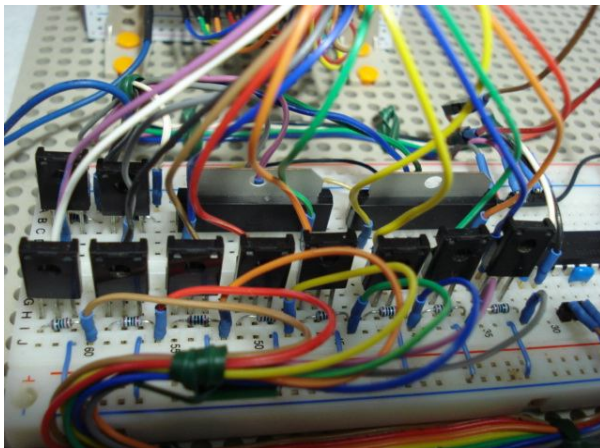
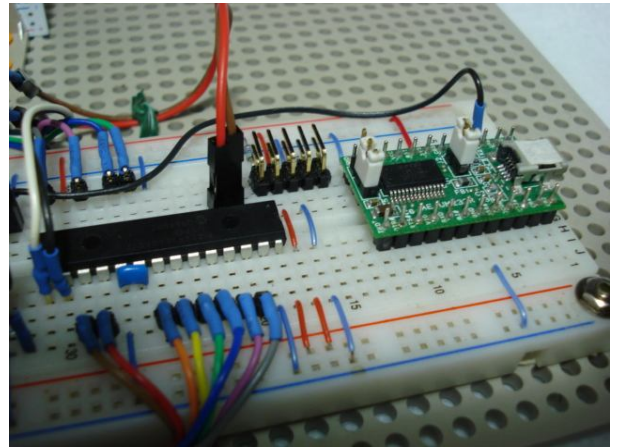
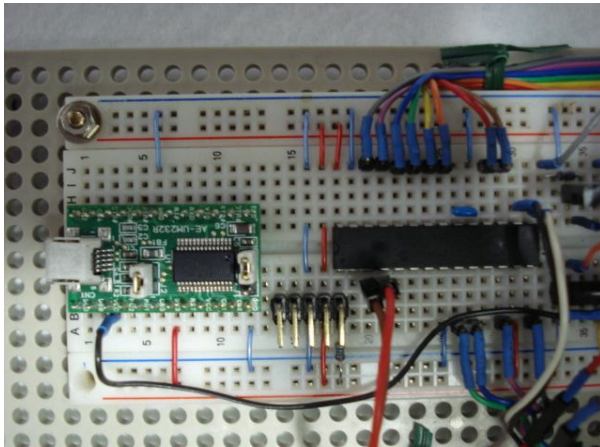

メモ

単なるメモです。